



CMX CM

DIGITAL MODULATING ELECTRIC BOILERS
ELECTRIC COMBI BOILERS

CMX15BG CM15BG

*Please read these instructions before installing or using this appliance for the first time.
These instructions must be followed for the safe installation of the boiler.
Any problem, fault or damage caused by the non-observance of these instructions will not
be covered under the manufacturer's warranty.
This manual should be retained with the appliance by the user for future reference.*

INDEX

| | |
|--|----|
| 1 IMPORTANT | 1 |
| 2 SAFETY | 1 |
| 3 INTRODUCTION | 2 |
| 3.1 DESIGN & OPERATION | 2 |
| 3.2 PRINCIPLE COMPONENTS | 2 |
| 3.3 KEY TO COMPONENTS | 2 |
| 3.4 SAFETY DEVICES | 3 |
| 4 INSTALLATION | 3 |
| 4.1 GENERAL REQUIREMENTS | 4 |
| 4.2 UNPACKING & CONTENTS | 4 |
| 4.3 LOCATION | 5 |
| 4.4 DIMENSIONS & CONNECTIONS | 5 |
| 4.5 CLEARANCES..... | 6 |
| 4.6 MOUNTING BRACKET | 6 |
| 4.7 WATER CONNECTIONS | 7 |
| 4.8 DHW DISCHARGE PIPE-WORK | 8 |
| 4.9 PUMP DUTY | 9 |
| 4.10 ELECTRICAL CONNECTIONS..... | 9 |
| 5 COMMISIONING | 11 |
| 5.1 LIMITING BOILER MAXIMUM OUTPUT | 11 |
| 5.2 HEATING SYSTEM INITIAL FILLING | 12 |
| 5.3 PUMP CHECKING & VENTING | 12 |
| 5.4 HEATING SYSTEM FLUSHING | 13 |
| 5.5 FILLING DOMESTIC HOT WATER | 13 |
| 6 OPERATING THE BOILER | 13 |
| 6.1 INITIAL SWITCHING ON | 13 |
| 6.2 CONTROL PANEL DESCRIPTION | 13 |
| 6.3 DHW OPERATION | 14 |
| 6.4 CENTRAL HEATING OPERATION | 15 |
| 6.5 ANTI-FREEZE MODE | 15 |
| 6.6 HEATING MODULATION FEATURE | 15 |
| 6.7 LOCKING THE CONTROL PANEL | 15 |
| 6.8 PUMP ANTI-SEIZE FUNCTION | 15 |
| 7 TROUBLESHOOTING | 16 |
| 7.1 POSSIBLE FAULTS & SOLUTIONS | 16 |
| 7.2 OVERHEAT LOCK-OUT & RE-SETTING..... | 17 |
| 7.3 HEATING FLOW SWITCH – E3 ERROR..... | 17 |
| 7.4 CHECKING RATED HEAT OUTPUT | 17 |
| 8 MAIN COMPONENTS LIST | 18 |
| 9 MAINTENANCE & CARE | 18 |
| 10 ENVIRONMENTAL INFORMATION | 18 |
| 11 TECHNICAL DATA | 19 |
| 12 EC DECLARATION OF CONFORMITY | 20 |
| 13 WIRING DIAGRAMS | 22 |

1 IMPORTANT

The following installation instructions are intended to guide the competent person throughout the entire installation process.

The boiler's guarantee does not cover any damaged caused by non-observance of any of these instructions.

These installation instructions and user's guide must be conserved and given to any new user.

The symbols used in the text are explained below:



WARNING

This indication shows the possibility of causing death from electric shock.



WARNING

This indication shows the possibility of causing death or serious injury.



CAUTION

This indication shows the possibility of causing injury or damage to properties only.



Symbol for useful information.

2 SAFETY

- This appliance is not destined for use by anyone (including children) with reduced physical, sensorial or mental capacities or those who do not know how to use the appliance, unless they are supervised or instructed by a person responsible for their safety.
- Check that the voltage on the indicator plate of the boiler coincides with the voltage of the mains circuit to which it is going to be connected.
- The use of these boilers in the presence of gases, explosives or inflammable objects is prohibited.
- The air inputs and outputs of the boiler ensure its correct operation and protect it from over-heating. They must never be covered.
- This boiler must be disconnected from the mains electricity before carrying out any internal repairs.
- The boiler must be installed in such a manner that the switches or other controls cannot be touched by anyone who is using the bath or shower.
- The installation must be performed in accordance with current electricity regulations.
- This appliance is destined to be permanently connected to a fixed installation. The power circuit of the boiler must incorporate an omni-polar cut-off switch with a separation between the contacts of at least 3 mm.
- The electricity supply circuit must incorporate a Residual-Current Device.
- This boiler must be earthed.

- All the models incorporate different safety elements. If one or more of them are activated, consult the section 7 TROUBLE SHOOTING.
- In time, the presence in the air of smoke, dust and pollution may stain the walls and areas close to the appliance.
- Any improper use is forbidden.
- Do not install the boiler in rooms prone to frost.

3 INTRODUCTION

3.1 DESIGN & OPERATION

The GabarronCM15BGboilers are electrically heated appliances providing wet central heating through a standard radiator system (or underfloor system with special kit).

The GabarronCMX15BGboilers are electrically heated combi boilers providing wet central heating through a standard radiator system (or underfloor system with special kit) and domestic hot water (DHW) delivered from an integral unvented store at mains water pressure.

Outputs are from 2 to 15kW. Maximum output can be adjusted to match the heat requirement of the system or the limitations of the incoming available power supply. Operation is possible on three phase 3x400V+N or single phase 230V - 50Hz.

The boilers are designed for internal installation on a suitable wall with consideration for the total weight of the appliance when full.

A digital control panel provides user control to adjust the temperatures of heating and hot water. A power modulation feature automatically adjusts the heating output to the demand to ensure economic operation.

A suitable external time clock/room thermostat should be fitted.

An adjustable thermostatic blending valve must be fitted on the hot water supply to ensure a safe and economic supply of hot water.

All components for sealed system central heating are built-in. A suitable filling loop should be fitted externally to comply with water supply regulations.

Heating and hot water functions will operate independently but not simultaneously with priority always to hot water production unless this function is not selected.

3.2 PRINCIPLE COMPONENTS

- Insulated steel boiler unit with immersed stainless steel elements INCOLOY800
- 50 L stainless steel domestic hot water store with CFC free insulation and immersed stainless steel elements INCOLOY800.
- Fully integrated electronic control boards featuring temperature control and modulation

function, pump over-run, anti-seize and frost protection. Self diagnostic fault information.

- Sealed system heating components: circulating pump, 6L expansion vessel, auto air-vent, 3 bar relief valve, pressure gauge, water flow switch and temperature limit safety thermostat.
- Unvented hot water components: 7 bar relief valve, 2l expansion vessel, non-return valve and temperature limit safety thermostat.
- Silent TRIAC power switches.
- Digital control board.

3.3 KEY TO COMPONENTS

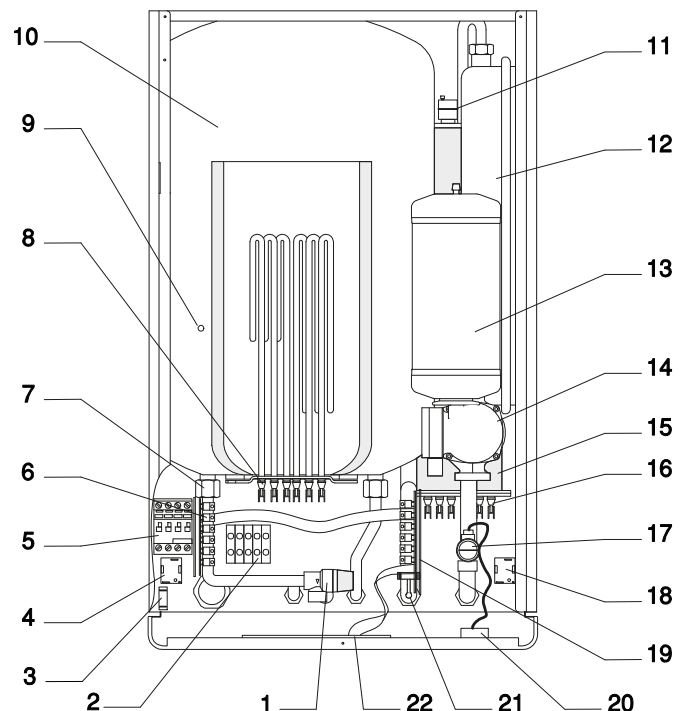

- 1 DHW 7 bar relief valve.
- 2 Connection block.
- 3 ON / OFF switch.
- 4 DHW safety thermal limit switch.
- 5 Main contactor.
- 6 DHW electronic PCB
- 7 Anti-electrolysis DHW hoses.
- 8 DHW resistance.
- 9 Temperature sensor location.
- 10 Insulated tank 50L.
- 11 Automatic purge.
- 12 Heating expansion vessel 6L.
- 13 DHW expansion vessel 2L.
- 14 Circulation pump.
- 15 Insulated heating header tank.
- 16 Heating resistance.
- 17 Heating 3 bar relief valve.
- 18 Heating safety thermal limit switch.
- 19 Main electronic PCB.
- 20 Pressure gauge.
- 21 Heating flow detector.
- 22 Controls card.

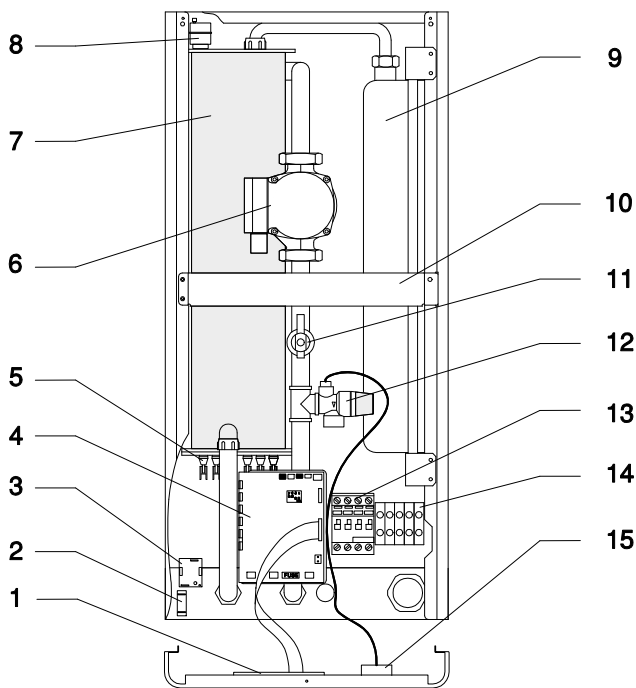

- 1 Controls card.
- 2 ON / OFF switch.
- 3 Heating safety thermal limit switch.
- 4 Main electronic PCB.
- 5 Heating resistance.
- 6 Circulation pump.
- 7 Insulated heating header tank.
- 8 Automatic purge.
- 9 Heating expansion vessel 6L.
- 10 Drip pan.
- 11 Heating flow detector.
- 12 Heating 3 bar relief valve.
- 13 Main contactor.
- 14 Connection block.
- 15 Pressure gauge.

3.4 SAFETY DEVICES

Safe operation under various conditions is ensured by the following controls:

- Water flow switch that monitors water flow in the heating system and will prevent operation in case of a blockage, if the system flowrate is below the permitted level, error E3 will appear. Installation of a system by-pass may be necessary (see 7.3 HEATING SYSTEM FLOW SWITCH – E3 ERROR & SYSTEM BY-PASS REQUIREMENTS).
- Hot water high limit safety thermostat will prevent operation if the temperature exceeds 80°C. It requires re-setting manually.
- Heating system high limit safety thermostat will prevent operation if the temperature exceeds 100°C. It requires re-setting manually.
- Hot water pressure relief valve will discharge to relieve excess pressure at 7 bar. (Requires piping to a safe external discharge point.)
- Heating system pressure relief valve will discharge to relieve excess pressure at 3 bar. (Requires piping to a safe external discharge point.)

4 INSTALLATION

IMPORTANT PRE- INSTALLATION POINTS



In order to ensure the successful installation and operation of your Gabarron boiler please consider the following points before commencing.

SITING THE BOILER



WARNING Wall and fixings must be suitable to support the total weight; CMX boiler when full is 120 kg, CM boiler when full is 50 kg.

Allow sufficient clearance and access for operating, maintenance and repair work.

Boiler must be protected from any water, moisture, or dampness.

Installation must comply with regulations for electricians if installed in bathrooms.

Boiler electrical protection rating is IP20/IP2X. This boiler is not designed to be installed in the open air.

The boiler must be installed in the upright position.

ELECTRICAL POWER SUPPLY & WIRING



WARNING Before carrying out any work inside the boiler and obtaining access to terminals, all supply circuits must be disconnected.



WARNING Earth the appliance. If the appliance is not earthed, it may hold voltage if a defect occurs.

Competency for electrical installation is required.

The power supply must meet the capacity for the heat output required plus all other appliance that may be supplied.

The cable, MCB and RCD must be of sufficient capacity to carry the required load.



Boiler is supplied set at maximum output and must be adjusted to suit the incoming supply before being switched on. (See 5.1 LIMITING BOILER MAXIMUM OUTPUT).

HEATING SYSTEM & CONTROLS

Any existing system must be suitable for sealed system operation at up to 3bar pressure and may require flushing/cleansing.

A combi filling loop, isolation valves and drain point are required.

A time clock/room thermostat should be installed. (Necessary to activate automatic power modulation)

System by-pass will be required for fully TRV systems.

The correct heat requirement for the dwelling should be calculated.

HOT WATER SYSTEM

Competency to install unvented hot water system is required.

Any existing system and controls (e.g. shower) must be suitable to operate at mains water pressure.

The incoming water main pressure and flow must be sufficient for requirements.

If incoming mains pressure is excessive (above 5 bar) a pressure reducing valve is required.

The boiler safety valves require piping to a safe discharge point.

In hard water areas it is advisable to take normal precautions against lime scale formation.

The installation should be carried out by a person certified as competent for the installation of unvented hot water systems in accordance with current building regulations.

Installation should also be in accordance with the relevant British Standards and Codes of Practice including the following:

BS 5449 Forced circulation hot water systems

BS 5546 Installation of hot water supplies for domestic purposes

BS 6700 Design, installation, testing and maintenance of services supplying water

BS7074 Application, selection and installation of expansion vessels and ancillary equipment for sealed water systems.

BS 7593 Code of Practice for treatment of water in heating systems

BS 7671 Requirements for electrical installations, IEE Wiring Regulations

4.1 GENERAL REQUIREMENTS

4.2 UNPACKING & CONTENTS

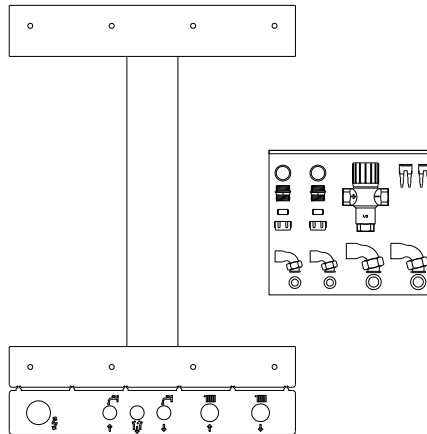
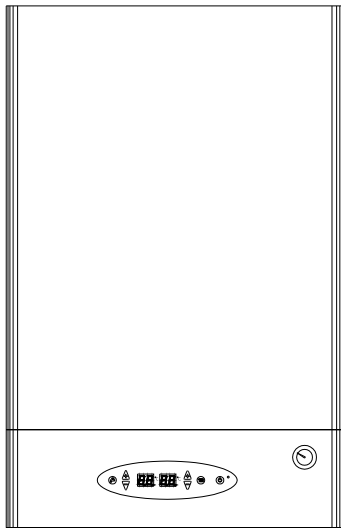

- Wall bracket with template.
- Boiler.
- Documentation.
- Bag with parts and fittings.

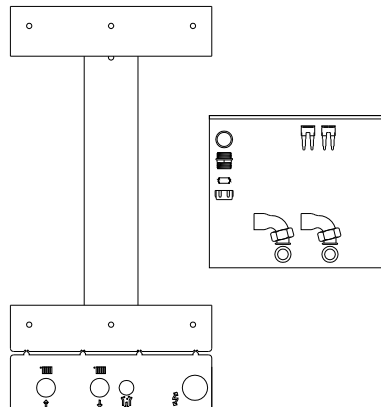
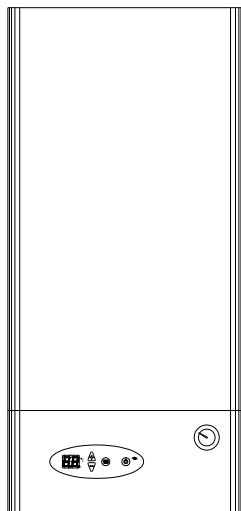

- Wall bracket with template.
- Boiler.
- Documentation.
- Bag with parts and fittings.



Dispose of the cardboard packaging at a cardboard recycling site. Observe national regulations.

4.3 LOCATION



WARNING INSTALL UPRIGHT ON A WALL SUITABLE TO SUPPORT THE TOTAL WEIGHT OF THE BOILER WHEN FULL OF WATER – 120 kg.

The location should be clean and dry with no presence of gases, explosives or flammable objects.

It is not suitable for installation outside and should be protected from moisture and frost.

The boiler must be sited so that the boiler and controls are not accessible to any persons whilst using a bath or shower and there should be no possibility of water dripping or splashing onto the boiler or controls.

Electrical safety regulations for clearances must be followed if installed in a bathroom or shower area.

The boiler has an electric protection rating of IP20/IP2X.

Where possible the boiler should be sited to minimize the pipe distance to hot water outlets.

The power supply cable should be carefully routed and secured and provision made for a suitable isolation switch and MCB/RCD.

4.4 DIMENSIONS & CONNECTIONS

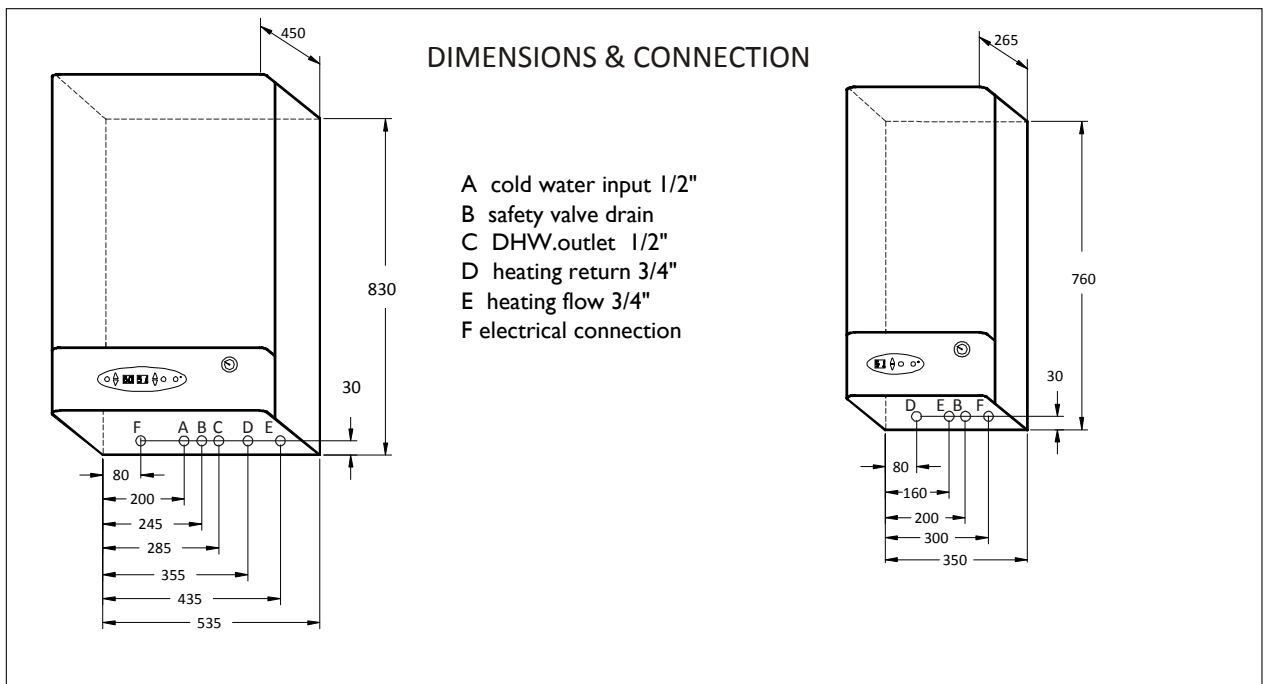

4.5 CLEARANCES

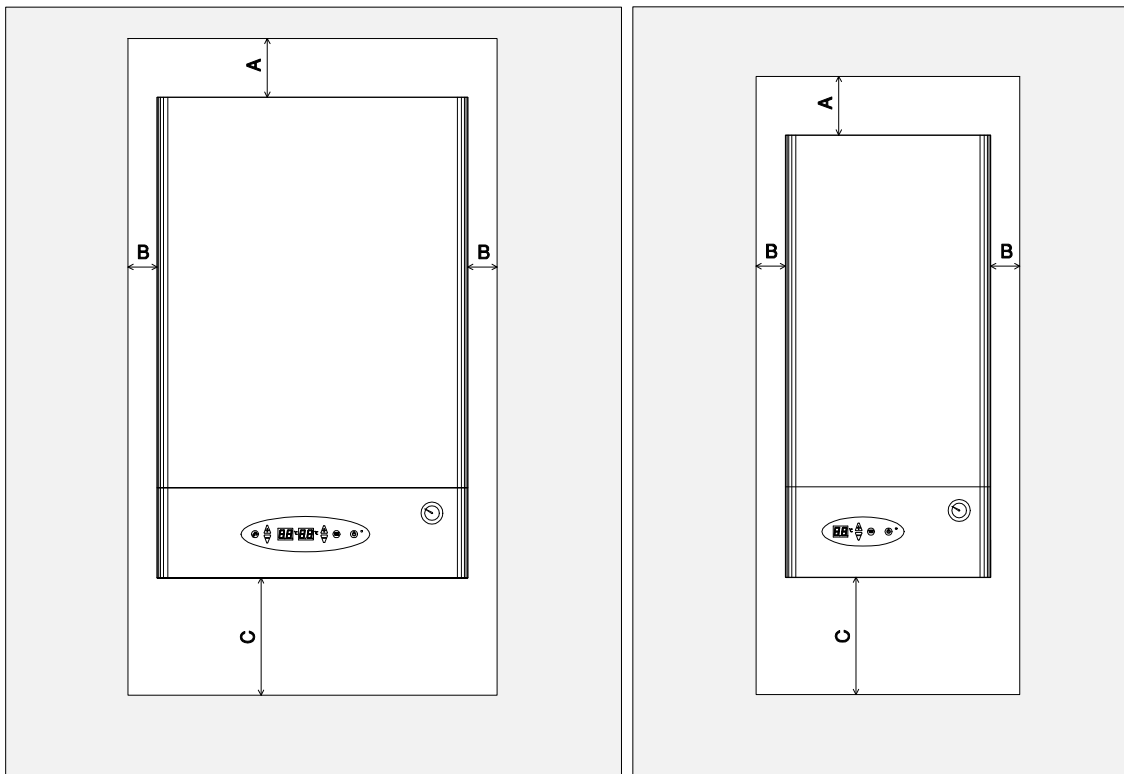

A: 50 mm B: 10 mm C: 200 mm

The clearances around the boiler as shown above must be observed for correct operation.

A minimum of 200mm clearance must be maintained underneath the boiler to allow replacement of the heating elements if required. A minimum of 500 mm clearance must be maintained in front of the boiler to enable easy access for servicing.

Ensure sufficient space to make all water connections including the outlet pipes for the heating and hot water safety valves which should be routed to a suitable discharge point.

4.6 MOUNTING BRACKET

Mark the holes positions using the wall bracket as a template per the diagram.

Fit bracket securely onto wall before lifting appliance into position. Drill the holes and fit the bracket ensuring it is level using suitable high strength screws, with appropriate plugs or fixings, minimum M10 size.

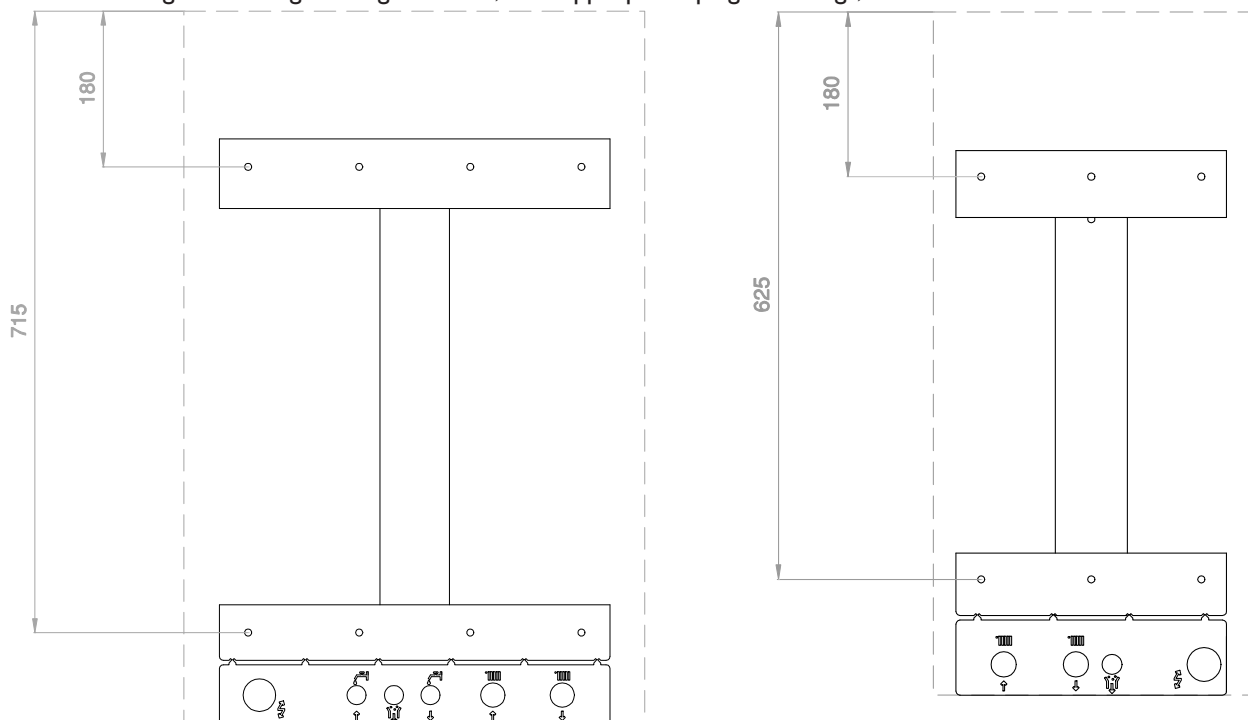

Always use assistance if required. Wear suitable cut resistant gloves when handling the appliance.

Ensure safe lifting techniques are used. Do not lift the appliance by attached pipe-work or components.

When lifting the boiler ensure that the fixing elements and the wall have a sufficient load-bearing capacity. Check the quality of the wall.

4.7 WATER CONNECTIONS



CAUTION The hydraulic connections must be carried out respecting the flow and return marked on the boiler.



CAUTION When tightening or loosening threaded connections, always use suitable tools as open-end spanners. Do not use pipe wrenches, extensions or unsuitable tools that may cause damage or water leaks.



Install purges in the radiators and high points of the installation.

Filling Loop

A combi filling loop is required for filling of the heating system and replacing water lost during servicing or bleeding and should be installed close to the boiler. The loop should be as shown in the diagram and comply with current Water Supply Regulations. The temporary connection should be removed after filling and the valves sealed with suitable caps.

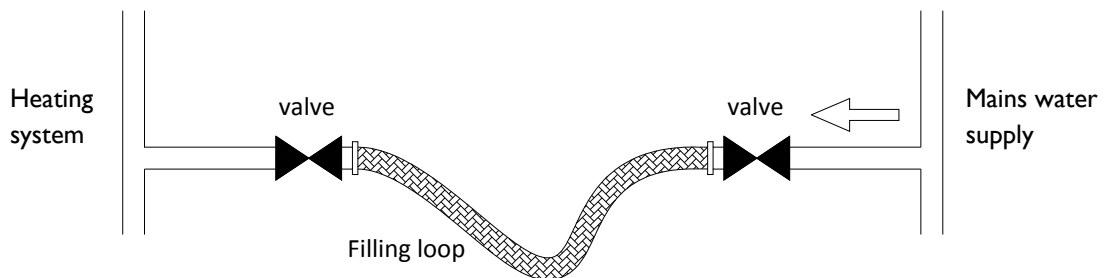

Heating Flow & Return

These connections are $\frac{3}{4}$ " for connection to 22mm pipe using the tails provided. Service valves should be installed at this position to allow the boiler to be isolated for maintenance without the need to drain the entire system. The valves should be of sufficiently large bore so not to restrict the heating circulation.

The boiler is not suitable for single pipe heating systems, only a twin-pipe heating system should be used.

Drain Point

A drain point should be fitted at the lowest point of the system. It is not acceptable to drain the boiler through the safety valve as debris and deposits will prevent correct operation of the valve.

Heating System By-pass

The heating water flow switch requires a minimum flow rate through the boiler of 7 L per minute for correct operation. Systems fitted throughout with Thermostatic Radiator Valves will require provision of a System By-pass to maintain sufficient flow should all the valves be closed. (see 7.3 HEATING SYSTEM FLOW SWITCH – E3 ERROR & SYSTEM BY-PASS REQUIREMENTS).

System Expansion

An integral 6 L expansion vessel provides for expansion of the heated system water under normal conditions however a system with larger volumes of water may require extra expansion capacity to be provided.

Cold Water Inlet

A ½” connection is provided for connection to 15mm pipe. An integral isolating valve provides control of the incoming water supply. An internal non-return valve prevents possible back-flow should the water main fail.



CAUTION: If the incoming water pressure exceeds 5 bar it is necessary to install a Pressure Reducing Valve set at 2.5 bar on the water main into the dwelling. This will protect the boiler and prevent constant opening of the 7 bar relief valve.

Hot Water Outlet

A ½” connection is provided for connection to 15mm pipe. To ensure economic operation the pipe run between the boiler and taps should be in not more than 15 mm dia. pipe and the distance as short as possible. The pipe-work should be insulated to reduce heat loss.

Safety Valve Connections

The 7 bar pressure relief valve on the domestic hot water store may discharge boiling water and should be piped to a safe but visible drain point e.g. a gully where any discharge will not cause damage or injury.



CAUTION: A tundish should be incorporated close to the appliance where any discharge will be visible but not hazardous. The pipe-work should have a continuous fall to the drain and should be of minimum 22mm dia. if more than one discharge is connected to it.

The 3 bar pressure relief on the sealed heating system may discharge boiling water and should be piped with a continuous fall to a safe yet visible point where any discharge cannot cause damage or injury.

4.8 DHW DISCHARGE PIPE-WORK

The CMX electric combi boiler range incorporates a 50 L unvented hot water storage vessel and an internal, temperature and pressure relief valve.



CAUTION: The discharge pipe-work from the T&P relief valve must be installed by a competent person and in accordance with Part G3 of The Building Regulations.

- The position of the tundish shall be visible to the occupants and shall be positioned away from any electrical device.
- The pipe size and distance from the T&P valve to the tundish and from the tundish to termination point must comply with the requirements of Part G3 of the Building Regulations
- The discharge pipe must fall continuously from the valve outlets and be un-obstructed
- The discharge pipe material must be capable of conveying water / steam at 100°C
- The final discharge point must be in a safe and visible position

Table 1 – Sizing of copper discharge pipe “D2” for common temperature relief valve outlet sizes

*Refer to paragraphs 3.5, 3.9, and 3.9(a) of Approved Document G

| Valve Outlet Size | Minimum size if discharge pipe D1* | Minimum size of discharge pipe D2* from tundish | Maximum resistance allowed, expressed as length of straight pipe (i.e. no elbows or bends) | Resistance created by each elbow or bend |
|-------------------|------------------------------------|---|--|--|
| G1/2 | 15mm | 22mm 28mm 35mm | Up to 9m Up to 18m Up to 27m | 0.8m 1.0m 1.4m |
| G3/4 | 22mm | 28mm 35mm 42mm | Up to 9m Up to 18m Up to 27m | 1.0m 1.4m 1.7m |
| G1 | 28mm | 35mm 42mm 54mm | Up to 9m Up to 18m Up to 27m | 1.4m 1.7m 2.3m |

Typical Discharge Pipe terminations (source: Building Regulation G3) :

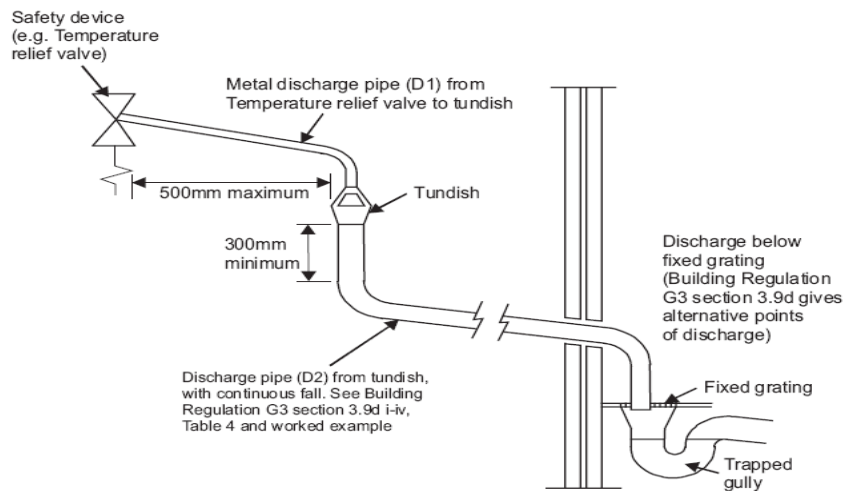

All installations must be fitted in accordance with all local regulations in force at that time. Failure to comply with these regulations will invalidate the manufacturers' warranty.

4.9 PUMP DUTY

Boiler equipped with a high efficiency circulation pump, with a maximum impulsion height of 6.2 m and a maximum flow of 3.3 m³ / h.

There are selectable operation modes with the built-in knob. You can select constant operating speeds I, II and III.

A LED indicator informs about the operating status of the pump

- Green: correct operation.
- Green / red flashing: Lower voltage $U < 180V$; overvoltage $U > 253V$; Module overheating
- Red flashing: pump blocked.

4.10 ELECTRICAL CONNECTIONS

Connection to Mains Supply

The CM15BG and CMX15BG boilers must be installed in premises having a system impedance of not more than $0.25 + j0.25\Omega$.

The CM15BG and CMX15BG boilers comply with the technical requirements of BS EN 61000-3-3.

The CM15BG and CMX15BG boilers must be installed in premises having a service capacity ≥ 100 A per phase.

Complete all the pipe-work before connecting the boiler to the electricity supply.

Any re-installation must be performed by qualified electricians.

Ensure that the mains voltage available coincides with that shown on the rating label.



WARNING IMPORTANT: CHECK THAT THE TOTAL POWER SUPPLY TO THE BUILDING HAS SUFFICIENT LOAD CAPACITY TO SUPPLY THE BOILER AT THE HEAT OUTPUT REQUIRED IN ADDITION TO ALL OTHER APPLIANCES THAT MAY BE SUPPLIED.



WARNING THE SUPPLY CABLE TO THE BOILER SHOULD BE OF SUFFICIENT SIZE TO CARRY THE LOAD CAPACITY REQUIRED. IT SHOULD BE WIRED THROUGH A LINKED ISOLATOR SWITCH WITH

MINIMUM CONTACT GAPS OF 3mm IN EVERY POLE AND PROTECTED BY A SUITABLY RATED CIRCUIT BREAKER MCB/RCD

Install the necessary electrical protections as indicated in the current regulations. In the event of these regulations not being complied with, the manufacturer will not be liable for any bodily injury or material damage that may occur.



WARNING IT IS ESSENTIAL THAT THE BOILER IS PROPERLY EARTHED and the wiring tested to current IEE regulations.

Electrical Supply Sizing

The following table shows the specification for a boiler installed on single phase supply.

| Rated output of boiler | 4kW | 5kW | 6kW | 7kW | 8kW | 9kW | 10kW | 11kW | 12kW | 13kW | 15kW |
|------------------------|-------|-------|-------|-------|-------|-------|-------|-------|-------|-------|-------|
| Supply current | 17.4A | 21.7A | 26.1A | 30.4A | 34.8A | 39.1A | 43.5A | 47.8A | 52.2A | 56.5A | 65.2A |
| MCB / RCD rating | 20A | 25A | 32A | 32A | 40A | 50A | 50A | 50A | 63A | 63A | 80A |
| Minimum cable size | 2.5mm | 4mm | 4mm | 6mm | 6mm | 10mm | 10mm | 10mm | 16mm | 16mm | 16mm |

Connection to Boiler



WARNING Touching live connections can cause serious personal injury.

Before establishing a mains connection switch off the power supply. Secure the power supply against being switched on again. Mains connection terminals remain live even if the on/off switch is turned off.

The boiler is delivered ready for operation on 3x400V three phase supply. For operation on 230V single phase the bridging connections supplied must be connected across the terminals of the connection block as shown.

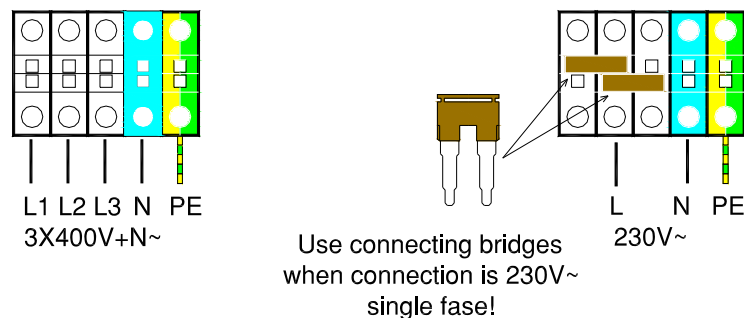

The terminal connection block is at the rear right-hand side of the boiler and is accessed after removing the boiler front panel. The supply cable should be safely routed to this point through the cable entry point on the right hand bottom of the boiler.



CAUTION: A mains voltage at the incorrect plug terminal can destroy the electronics.



Make sure the connectin cables are securely fastened to the plug terminals.

Wiring External Controls

It is recommended that the boiler is controlled by an external control such as a time clock or room thermostat or a combined programmable room thermostat such as the Elnur model CTP-10.



CAUTION: The switching connection of this control should be VOLT FREE and connected to the terminals indicated 'TA' on the PCB. The factory fitted link across these terminals must be removed.

The boiler's automatic power modulation feature is activated by the initial interruption of this switching link.

5 COMMISSIONING

5.1 LIMITING BOILER MAXIMUM OUTPUT

The boiler is supplied for operation on maximum heat output of 15kW. The output can be rated below this maximum to match the heat load required.



WARNING: ON INSTALLATIONS WHERE THE INCOMING POWER SUPPLY IS NOT CAPABLE OF MAXIMUM LOAD THE BOILER CONTROL MUST BE RE-CONFIGURED TO LIMIT THE OUTPUT BEFORE SWITCHING ON.

As the output for Domestic Hot Water will also be limited to the same level it is recommended to adjust to the highest output possible so as to maintain the best hot water performance.

The boiler will not exceed this pre-set maximum but will still modulate in heating mode up to this level, adapting to demand and ensuring economic operation.

Adjustment is made by selecting the desired position of switches numbered 1 to 4 in a block situated on the main PCB. The PCB is located after isolating from the mains, removing the case and tilting the control panel.



The switches are positioned upside down as shown below.



Location of electronic card.

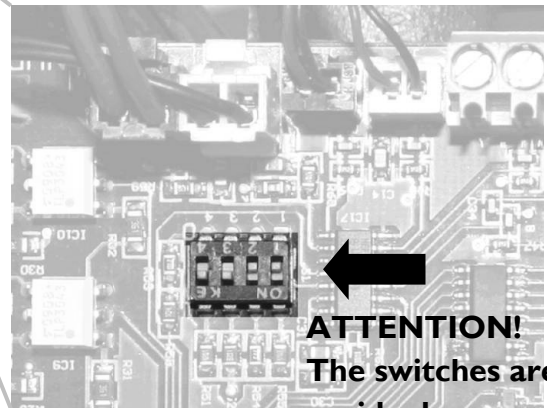

With a small screwdriver move the switches to correspond to the positions shown in the tables for the required output, referring to a single or three phase supply.

Correct configuration for the selected output can be checked on the boiler display panel following the procedure shown in 7.4 CHECKING RATED HEAT OUTPUT.



CAUTION: It is essential to confirm the power output with the use of a clamp meter.

LIMITATION OF OUTPUT ON MODELS CM15 & CMX15

| Connection THREE-PHASE 3x400V~+N | | | | | Connection SINGLE PHASE 230V~ | | |
|----------------------------------|-----------------------------|-------|-------|-------|-------------------------------|-----------------------------|--------|
| POSITION OF THE SWITCHES | MAXIMUM OUTPUT LIMITED TO : | | | | POSITION OF THE SWITCHES S | MAXIMUM OUTPUT LIMITED TO : | |
| | 15kW | 21.7A | 21.7A | 21.7A | | 15kW* | 65.2A* |
| | 13kW | 13.0A | 21.7A | 21.7A | | 13kW* | 56.5A* |
| | 12kW | 21.7A | 21.7A | 8.7A | | 12kW | 52.2A |
| | 11kW | 13.0A | 13.0A | 21.7A | | 11kW | 47.8A |
| | 10kW | 21.7A | 8.7A | 13.0A | | 10kW | 43.5A |
| | 9kW | 13.0A | 13.0A | 13.0A | | 9kW | 39.1A |
| | 8kW | 13.0A | 8.7A | 13.0A | | 8kW | 34.8A |
| | 7kW | 8.7A | 13.0A | 8.7A | | 7kW | 30.4A |
| | 6kW | 8.7A | 8.7A | 8.7A | | 6kW | 26.1A |
| | 5kW | - | 13.0A | 8.7A | | 5kW | 21.7A |
| | 4kW | 8.7A | 8.7A | - | | 4kW | 17.4A |
| | 3kW | - | - | 13.0A | | 3kW | 13.0A |
| | 2kW | 8.7A | - | - | | 2kW | 8.7A |

* The standard configuration of the boiler only allows a maximum of 12kW when connected SINGLE-PHASE 230V – 50Hz.

5.2 HEATING SYSTEM INITIAL FILLING

Ensure both flow and return isolation valves are open. Identify the boiler automatic air release valve at the top right hand side of boiler and loosen the cap. Close any manual air vents fitted on the system.

Be careful not to splash any of the electrical components.

Connect the filling loop and fill slowly until the pressure gauge indicates between 1 and 1.5 bar.

Proceed to vent all the manual release valves until all air is purged from the system. It will be necessary to top-up through the filling loop during this operation.

5.3 PUMP CHECKING & VENTING

Sometimes (i.e. if display fault E3) it is necessary to check that the pump is properly vented and spinning freely.

To purge the pump, turn on the boiler and with the pump selector, alternate between positions III and Min every fifteen seconds. Keep this operation for 5 minutes.

If excess air remains in the system or there is insufficient pressure or flow rate the boiler will fail to operate and display fault E3.

A LED indicator informs about the operating status of the pump:

- Green: correct operation.
- Green / red flashing: Lower voltage $U < 180V$; overvoltage $U > 253V$; Module overheating
- Red flashing: pump blocked.

5.4 HEATING SYSTEM FLUSHING



CAUTION: Flush the heating installation thoroughly prior to installation.

The heating system should be flushed in accordance with BS7593 & BS5449 which will remove any debris or contaminants detrimental to the operation and life of the boiler. Any cleanser or additives used should comply with current standards and the manufacturer’s instructions carefully followed.

NOTE: IT IS IMPORTANT NOT TO USE THE BOILER PRESSURE RELIEF VALVE TO DRAIN OR FLUSH THE SYSTEM AS TRAPPED DEBRIS WILL CAUSE INCORRECT OPERATION. A PURPOSE PROVIDED DRAIN POINT SHOULD BE USED.

5.5 FILLING DOMESTIC HOT WATER

Open the mains water inlet valve underneath the boiler. Turn on all the hot water system taps and thoroughly flush allowing water to flow until no air is present. This will automatically vent the integral hot water store of any air.

6 OPERATING THE BOILER

6.1 INITIAL SWITCHING ON



CAUTION: THE MAXIMUM HEAT OUTPUT MUST BE ADJUSTED BEFORE SWITCHING ON. THE BOILER SHOULD NEVER BE SWITCHED ON WITH THE HEATING SYSTEM OR DHW TANK EMPTY. DAMAGE COULD OCCUR.



When the boiler is first connected it will perform a general self-check and if a fault is detected it will be indicated on the display.

Turn on the boiler with the on/off switch located at the back of the boiler as shown.

Mains connection terminals remain live even if the on/off switch is turned off.

6.2 CONTROL PANEL DESCRIPTION

MODELS CMX15BG

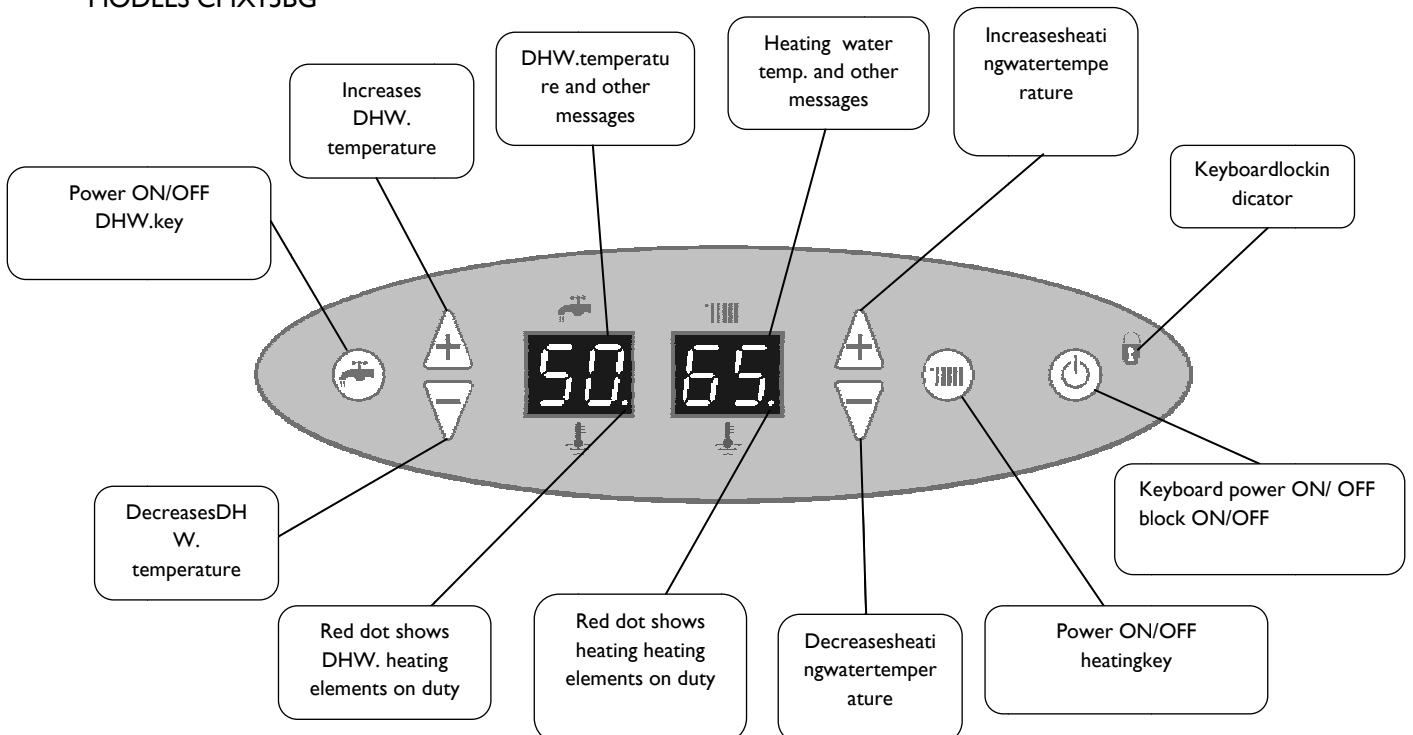

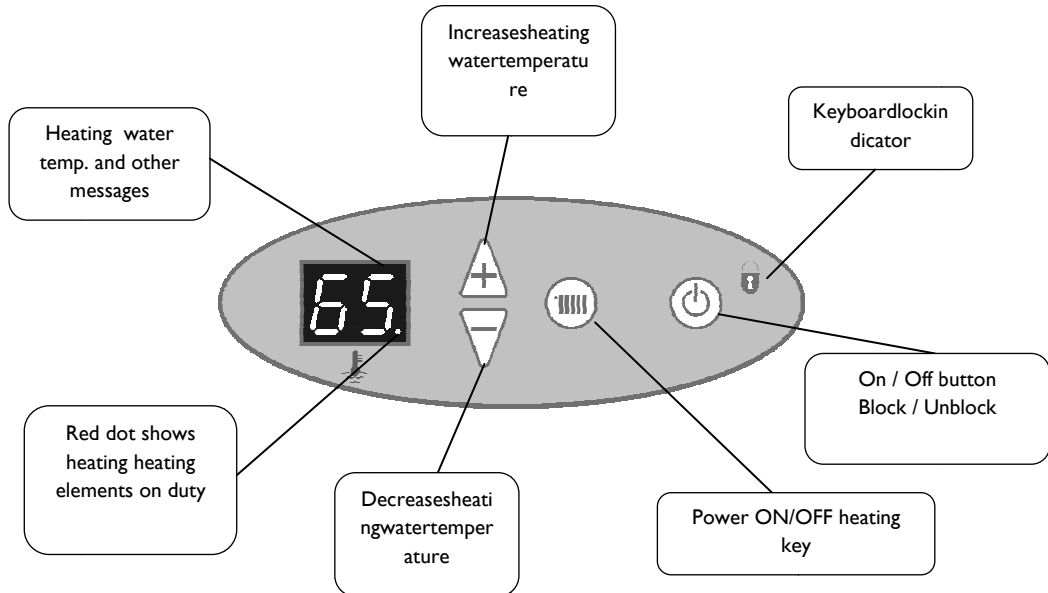

Push the  button to start the boiler up. The same button will turn the boiler off when pushed again.

If the heating or DHW function are not selected the relevant screen will not display a value but just a red dot.

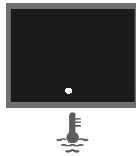

6.3 DOMESTIC HOT WATER OPERATION

To select the DHW function push the  button. Pushing again will switch the function off and return display to just a red dot.





When the DHW mode is selected the display will show the actual temperature in the DHW accumulation tank. The boiler will always give priority to DHW production over central heating until the selected DHW temperature is reached.

If heat is demanded by the DHW and the elements are energized a small red indicator is displayed to the right of the temperature display.



This light will go out when the desired temperature is reached.

The setting of the DHW temperature can be modified by pushing either the  button or the  button and using the same buttons to adjust the setting that flashes on the display. The modified setting will be stored automatically after a few seconds, or instantly if we push the  button.

The DHW setting can be varied between 20 and 55°C.

 The DHW has priority over the central heating operation and so the outputs are never added together.

 Water storage at maximum temperature will provide the best protection against the possible formation of legionella bacteria.



6.4 CENTRAL HEATING OPERATION

First ensure that any external controls such as room thermostat or time clock are demanding heat.

To select the heating function, push the  button. Pushing again will switch the function off and return display to just a red dot.

When the heating mode is selected the display will show the temperature of the heating water.



We can modify the setting of the temperature of the water by pushing either the  button or the  button and using the same buttons to adjust the value that flashes on the display.

The modified setting will be stored after a few seconds or instantly if we push the  button.

The heating setting can be varied between 8°C and 85°C. The symbol H appears after the 85 value or before the 8 value. If we select this value, the heating will function in anti-freeze mode.

If the setting is higher than the actual temperature of the heating water and the DHW is not connected, the heating will connect and a small red indicator of the consumption of heating resistances will light up.



6.5 ANTI-FREEZE MODE (Frost Protection)

It is possible to select an anti-freeze mode for frost protection during periods of inactivity. The power supply to the boiler must be maintained.

By attempting to set a central heating temperature below the 8°C value or above the 85°C value the symbol H will appear on the display. By selecting this value the heating will only work in anti-freeze mode i.e. if the boiler temperature falls to 7°C the heating will activate automatically.

6.6 HEATING MODULATION FEATURE



The advanced control board on the boiler will automatically modulate the heating output to the demand required to save energy.

This function works by the boiler 'learning' and anticipating the time taken to reach the temperature level demanded by the external thermostatic control. The power output is automatically adjusted therefore reducing power consumption on warmer days or when another heat source is present.

An external 'volt free' control must be fitted across the terminals marked 'TA' on the PCB and the 'bridge' removed for this function to be activated.

6.7 LOCKING THE CONTROL PANEL

It is possible to lock the buttons of the control panel to prevent any adjustment.

By keeping the  button pressed down for a few seconds, the padlock will light up .

The control buttons of the boiler will be locked and no button will respond when pressed. Internally all the settings remain the same and the boiler will function normally.

To unlock the buttons, press the same button down for a few seconds until the padlock light goes off. If the boiler is disconnected from the mains or there is a failure in the house's electricity supply, the buttons will also be unlocked.

6.8 PUMP ANTI-SEIZE FUNCTION

The advanced boiler control will automatically energize the pump for 10 seconds each month to protect it from seizing during long periods of inactivity. The power supply must be maintained for this function to operate.

7 TROUBLESHOOTING

7.1 POSSIBLE FAULTS & SOLUTIONS

| Problem | Possible cause | Solution |
|---|---|--|
| Boiler will not start | No power to boiler. | Check incoming power supply. |
| | No power. | Check boiler control switch is on. (See Section 6.1.) |
| | Heating overheat. Switch tripped. | Locate switch and reset. (See Section 7.2) |
| | DHW Overheat switch tripped. | Locate switch and reset. (See Section 7.2) |
| | DHW tank empty. | Open a hot water tap until the water flows. |
| Fault E1 displayed Heating flow temperature sensor | Heating water out temperature probe defective. | Contact Technical Service |
| Fault E2 displayed Heating return temperature sensor | Heating water return temperature probe defective. | Contact Technical Service |
| Fault E3 displayed Heating system water flow switch | Low heating system pressure. | Check for leaks. Refill heating system to 1.5 bar. |
| Fault E3 continued | Pump not turning. | Check rotating freely (sect 5.3) Replace pump if necessary. |
| Fault E3 continued | Air in system. | Purge thoroughly. Check automatic air valve open. Vent pump (sect 5.3) |
| Fault E3 continued | System resistance too high or blockage. | Check pump speed 3. Check pump duty (sect 4.9) Open all radiator valves. Install system by-pass. |
| Fault E5 displayed | Error in configuration for maximum heat output. | Check correct configuration (See Section 5.1) |
| Fault E6 displayed DHW temperature sensor | Defective DHW tank temperature sensor. | Check connections. Replace sensor if necessary. |
| Heating system water discharging from 3 bar safety valve | Excessive heating system pressure. | Check filling loop not passing and remove. Check expansion vessel is charged with air. Check system expansion volume. |
| Domestic water discharging from 7 bar valve | Excessive pressure in domestic water system. | Check incoming mains pressure is below 5 bar. Fit pressure reducing valve. Check 2L expansion vessel charged with air. |
| The buttons do not respond | Control panel blocked | See Section 10.2 BLOCKING THE CONTROLS |
| Low heating temperature | Settings too low. | Check temperature & output selected. |
| | Failure of heating elements | Check and replace. |
| | Heat requirements miscalculated. | Re-calculate & configure. |

If the suggested action fails to resolve a problem please contact **ELNUR** technical service for further advice.

7.2 OVERHEAT LOCK-OUT & RE-SETTING

Central heating overheat.

If the boiler detects a overheat condition of 100°C (80°C if adapted floor heating) in the central heating circuit a safety thermal limit switch will operate and switch the boiler off disabling all functions including DHW production. The cause of the overheat should be investigated.

The safety limit switch is on the left underside of the boiler and will require re-setting manually by following the procedure shown:

Unscrew & remove the black cap and push the small pin behind it until you hear a click.

The limiter will not re-set until the temperature in the heating header drops below 100°C or 80°C if the boiler is adapted for radiant floor heating.

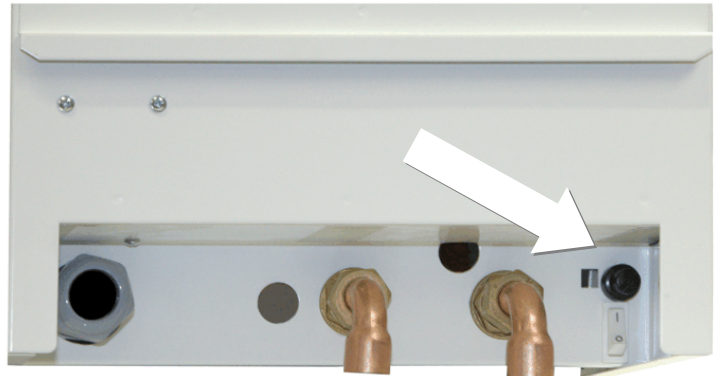

Domestic Hot Water overheat.

As with the heating circuit a second thermal limit switch, situated on the right underside of the boiler, will operate if a overheat condition (80°C) is detected in the DHW circuit and switch the boiler off disabling all functions including central heating.

The cause should be investigated and the above procedure followed to re-set the DHW limit switch.

7.3 HEATING SYSTEM FLOW SWITCH – E3 ERROR& SYSTEM BY-PASS REQUIREMENTS

If the error E3 appears on the display, the flow switch has detected insufficient water flow in the heating circuit and heat production is disabled to protect the boiler from overheating.



The possible causes for this condition are:

- Insufficient water pressure in the heating system requiring re-filling to 1.5bar
- Pump not circulating or seized. Check as shown (Sect 5.3)
- Blockage in heating circuit from debris or a foreign object in the boiler or pipe-work.
- Insufficient flow rate caused by restrictions such as insufficient size pipe-work, too many bends or isolation valves with restricted bore.
- Closed radiator valves (Thermostatic). In this situation it is essential the required minimum flow rate of 7 L per minute is maintained through the boiler during all conditions. It may be sufficient to maintain one radiator with permanently open valves however the guidance under current Building Regulations relating to the conservation of energy recommends the fitting of an automatic by-pass valve. This type of valve modulates open when necessary to ensure that the appropriate minimum flow rate is maintained through the boiler, at all other times it is closed thus preventing unnecessary and wasteful circulation through the bypass and the boiler.

7.4 CHECKING RATED HEAT OUTPUT



It is possible to check the actual heat power output configuration that is set on the boiler and also the modulated operating output at that moment.



Press the button for three seconds.



The heating display will show followed by the temperature value of the return probe of the heating circuit.



On pushing button the display will show followed by the value of the limited maximum output according to the tables (see 5.1).



On pushing button again the display will show followed by the actual modulated output power at that moment.



8 MAIN COMPONENTS

| | | | |
|--------------------------------------|---------------|------------------------------------|---------------|
| Heating expansion vessel 6L | ref. 60091510 | 15 kW DHW.resistance& joint | ref. 60100700 |
| DHW.expansion vessel 2L | ref. 60091515 | DHW.resistance joint | ref. 60100068 |
| DHW.expansion vessel hose CMX | ref.60100020 | ¾" heating flow detector | ref. 60100805 |
| 50 LDHW.insulated tank | ref. 60100072 | 0-4 bar pressure gauge | ref. 60100820 |
| Insulated heating header tank | ref. 60101700 | 100°C thermal limiter | ref. 60101860 |
| Circulation pump RKC130 | ref. 60190076 | 80°C thermal limiter | ref. 60101870 |
| Main electronic card with support | ref. 60101310 | Automatic purge | ref. 60091280 |
| DHW.electronic card with support | ref. 60101320 | 3 bar central heating relief valve | ref. 60100840 |
| Controls card CM15G&CM18G | ref. 60100510 | 7 bar DHW. relief valve | ref. 60100850 |
| Controls card CMX15G&CMX18G | ref. 60100540 | DHW.retention valve | ref. 60100830 |
| Temperature probe, white connector | ref. 60100580 | ½" filling / shut off valve | ref. 60091160 |
| Temperature probe, black connector | ref. 60100590 | Adhesive controls cover 220x60 | ref. 60100502 |
| 15 kW heating resistance & joint 140 | ref. 60100750 | Adhesive controls cover 140x50 | ref. 60100508 |
| 18 kW heating resistance & joint 140 | ref. 60100760 | | |

9 MAINTENANCE & CARE

Gabarrón electric boilers do not require any special maintenance for a prolonged and trouble-free life however the following points should be observed:

-Check and maintain the heating system pressure between 1 & 1.5 bar when cold. Frequent re-filling of the system could cause scaling and corrosion and should be avoided. Regular pressure loss could indicate a leak and should be investigated promptly.



CAUTION –Under no circumstances should the boiler be switched on when the system is dry..



CAUTION - Never start the boiler when the DHW tank is empty; to fill it for the first time open a hot water tap and wait until water comes out of it.

-Keep the ventilation openings on the boiler clear to ensure correct operation and protect from overheating. Do not place or store objects on the boiler.

-Protect against freezing by ensuring power is maintained to the boiler at all times unless the water supply is interrupted or the heating system is empty. In dwellings frequently un-occupied or at risk of freezing an appropriate anti-freeze can be added to the heating system at a concentration of not more than 30% by volume. Otherwise it is recommended to isolate the power and completely drain the heating and hot water systems.

- The outer case can be cleaned with a damp cloth having first isolated the boiler from the mains. Do not use solvents or abrasive cleaners.

10 ENVIRONMENTAL INFORMATION

Gabarrón boilers are manufactured within a certified environmental management system. From the design stage, all the production phases are performed taking into account the most rigorous environmental requirements. For example, the selection of materials involves guaranteeing their biodegradability, re-use and recycling.

When this boiler's long, useful life is over; it must be handed in to an electrical equipment collection point for proper recycling. By ensuring that this product is correctly disposed of, you will help to avoid any possible negative effects on the environment and public health that could occur if this product is not properly handled. To obtain more detailed information on the recycling of this product, contact your local authority, your waste disposal service or the shop where you purchased the product.

These regulations only apply in EU member countries.

II TECHNICAL DATA

| | | CMX15BG | CM15BG |
|---|---------|----------------|----------------|
| Frequency | Hz | 50 | 50 |
| Connection 3x400V+N~ | | ◆ | ◆ |
| Output limited to 15kW ; Maximum intensity | A | 21.7 | 21.7 |
| Output limited to 13kW ; Maximum intensity | A | 21.7 | 21.7 |
| Output limited to 12kW ; Maximum intensity | A | 21.7 | 21.7 |
| Output limited to 11kW ; Maximum intensity | A | 21.7 | 21.7 |
| Output limited to 10kW ; Maximum intensity | A | 21.7 | 21.7 |
| Output limited to 9kW ; Maximum intensity | A | 13.0 | 13.0 |
| Output limited to 8kW ; Maximum intensity | A | 13.0 | 13.0 |
| Output limited to 7kW ; Maximum intensity | A | 13.0 | 13.0 |
| Output limited to 6kW ; Maximum intensity | A | 13.0 | 13.0 |
| Output limited to 5kW ; Maximum intensity | A | 13.0 | 13.0 |
| Output limited to 4kW ; Maximum intensity | A | 13.0 | 13.0 |
| Output limited to 3kW ; Maximum intensity | A | 13.0 | 13.0 |
| Connection 230V~ single phase | | ◆ ¹ | ◆ ¹ |
| Nominal maximum intensity 15kW | A | 65.2 | 65.2 |
| Maximum converted intensity at 13kW | A | 56.5 | 56.5 |
| Maximum converted intensity at 12kW | A | 52.2 | 52.2 |
| Maximum converted intensity at 11kW | A | 47.8 | 47.8 |
| Maximum converted intensity at 10kW | A | 43.5 | 43.5 |
| Maximum converted intensity at 9kW | A | 39.1 | 39.1 |
| Maximum converted intensity at 8kW | A | 34.8 | 34.8 |
| Maximum converted intensity at 7kW | A | 30.4 | 30.4 |
| Maximum converted intensity at 6kW | A | 26.1 | 26.1 |
| Maximum converted intensity at 5kW | A | 21.7 | 21.7 |
| Maximum converted intensity at 4kW | A | 17.4 | 17.4 |
| Maximum converted intensity at 3kW | A | 13.0 | 13.0 |
| DHW available time with 15kW | min | 5'49" | - |
| DHW available time with 13kW | min | 6'42" | - |
| DHW available time with 12kW | min | 7'16" | - |
| DHW available time with 11kW | min | 7'56" | - |
| DHW available time with 10kW | min | 8'43" | - |
| DHW available time with 9kW | min | 9'41" | - |
| DHW available time with 8kW | min | 10'54" | - |
| DHW available time with 7kW | min | 12'27" | - |
| DHW available time with 6kW | min | 14'32" | - |
| DHW available time with 5kW | min | 17'26" | - |
| DHW available time with 4kW | min | 21'48" | - |
| DHW available time with 3kW | min | 29'04" | - |
| DHW available time with 2kW | min | 43'36" | - |
| Weight | kg | 70 | 32 |
| Insulated steel heater header | | ◆ | ◆ |
| 50 L stainless steel insulated DHW store | No CFC | ◆ | - |
| Stainless steel plated resistance elements INCOLOY800 | DHW | ◆ | - |
| Stainless steel plated resistance elements INCOLOY800 | Heating | ◆ | ◆ |
| 6 litre expansion vessel | | ◆ | ◆ |
| DHW 2 litre expansion vessel | | ◆ | - |
| Electronic regulation of heater modulation | | ◆ | ◆ |
| Electronic regulation DHW | | ◆ | - |
| Digital display | | ◆ | ◆ |
| 0-4 bar pressure gauge | | ◆ | ◆ |
| Accelerator pump | | ◆ | ◆ |
| Automatic purge | | ◆ | ◆ |
| TRIACS silent power switches | | ◆ | ◆ |
| Heating flow detector | | ◆ | ◆ |
| 100°C heating temperature limiter | | ◆ | ◆ |
| 80°C DHW temperature limiter | | ◆ | - |
| 3 bar central heating relief valve | | ◆ | ◆ |
| 7 bar DHW relief valve | | ◆ | - |
| DHW retention valve | | ◆ | - |
| Ambient thermostat intake | | ◆ | ◆ |
| Anti-electrolysis DHW hoses | | ◆ | - |
| Water heating declared load profile | L | - | - |
| Space heating energy efficiency class | D | D | D |
| Water heating energy efficiency class | D | - | - |
| Rated heat output | kW | 15 | 15 |
| Annual electricity consumption (AEC) | kWh | 2806 | - |
| Space heating energy efficiency (η_s) | % | 37 | 37 |
| Water heating energy efficiency (η_{wh}) | % | 37 | - |
| Sound power level (L _{wa}) | dB | 36 | 36 |

◆ included¹ using connecting bridge included



DECLARACION DE CONFORMIDAD

De acuerdo con la norma ISO / IEC 17050-1

DECLARATION OF CONFORMITY

According to the Standard ISO / IEC 17050-1

N° 6610000 and 6620000

Nombre del fabricante : ELNUR, S.A.
Manufacturer's name :

Dirección del fabricante : ELNUR, S.A.
Manufacturer's address : P.I. El Nogal. Villa Esther, 11
28110 Algete, Madrid, Spain

Declara que el producto : Caldera modulante digital sólo calefacción "CMBG"
Caldera modulante digital de calefacción y A.C.S. "CMXBG"
Declares, that the product : "CMBG" Heating digital modulating boiler
"CMXBG" Heating and D.H.W. digital modulating boiler

Marca : GABARRÓN
TradeMark :

Modelos : CMI5BG, CMX15BG
Models :

ha sido fabricado conforme a las especificaciones técnicas del producto y cumple en todo las Normas vigentes, en particular:

has been manufactured to the technical specifications of the product and conforms in all respects to the relevant standards and regulations in force and especially to :

Seguridad : EN 60335-1:2012+A11:2014
Safety : EN 60335-2-35:2002+A1:2007+A2:2011
EN 50106:2008

EMC : EN 55014-1:2006+A1:2009+A2:2011
EN 55014-2:1997+A1:2001+A2:2008
EN 61000-3-2:2006+A1:2009+A2:2009
EN 61000-3-3:2008

Información adicional :
Additional information :

El producto aquí citado se halla en conformidad con la Directiva de Baja Tensión 2006/95/CE y la Directiva de EMC 2004/108/CE y lleva el marcado CE.

Cualquier uso que no esté de acuerdo con las instrucciones y/o cualquier cambio al aparato invalidarán esta declaración de conformidad.

The product herewith complies with the requirements of the Low Voltage Directive 2006/95/EC and the EMC Directive 2004/108/EC and carries the CE mark.

Any use not according to the instructions and/or any change to the appliance will invalidate this declaration of conformity.

Algete, 31 de Agosto de 2015
Place, Date

Alberto Fernández
Director Gerente
ELNUR, S.A.

13 WIRING DIAGRAMS

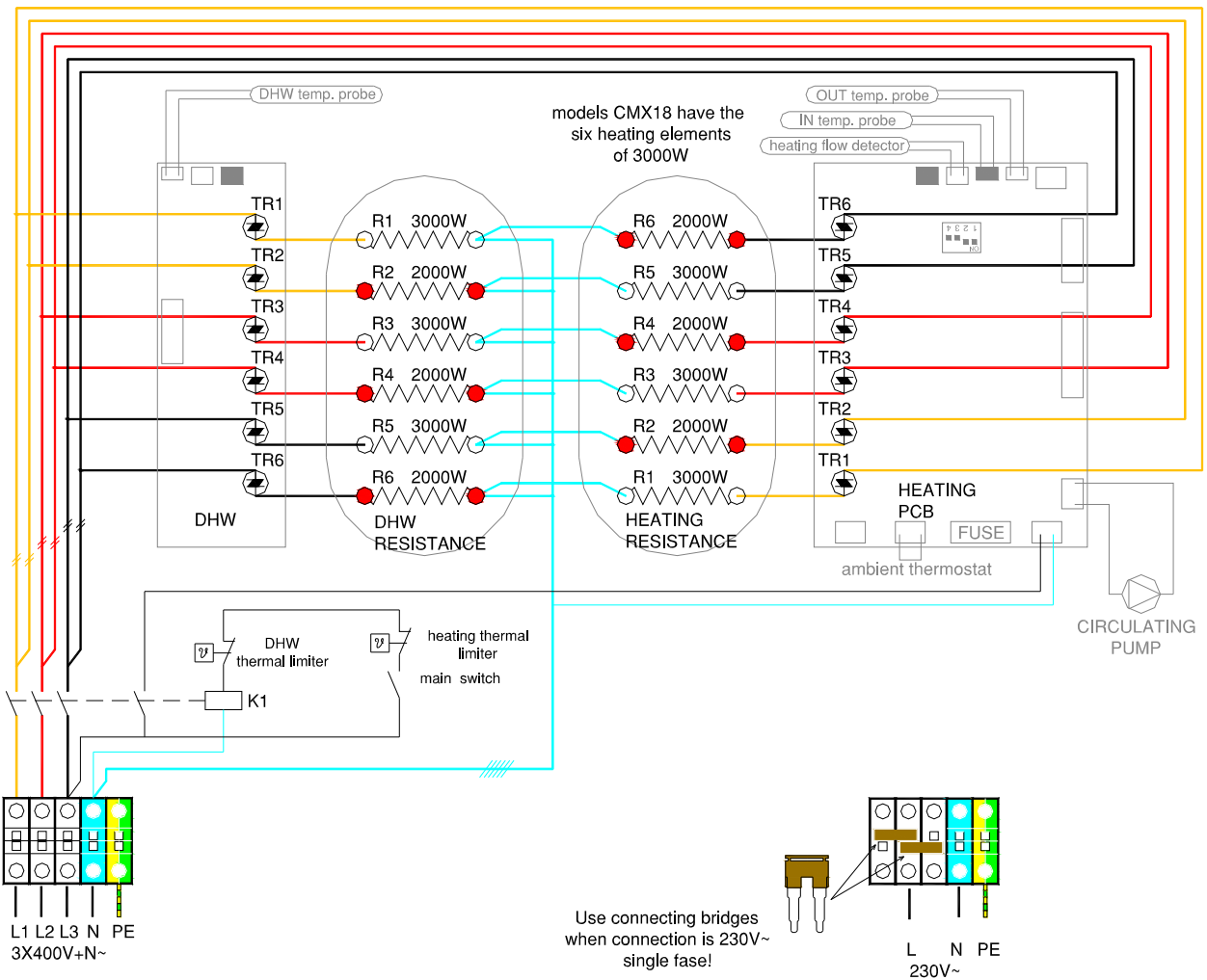
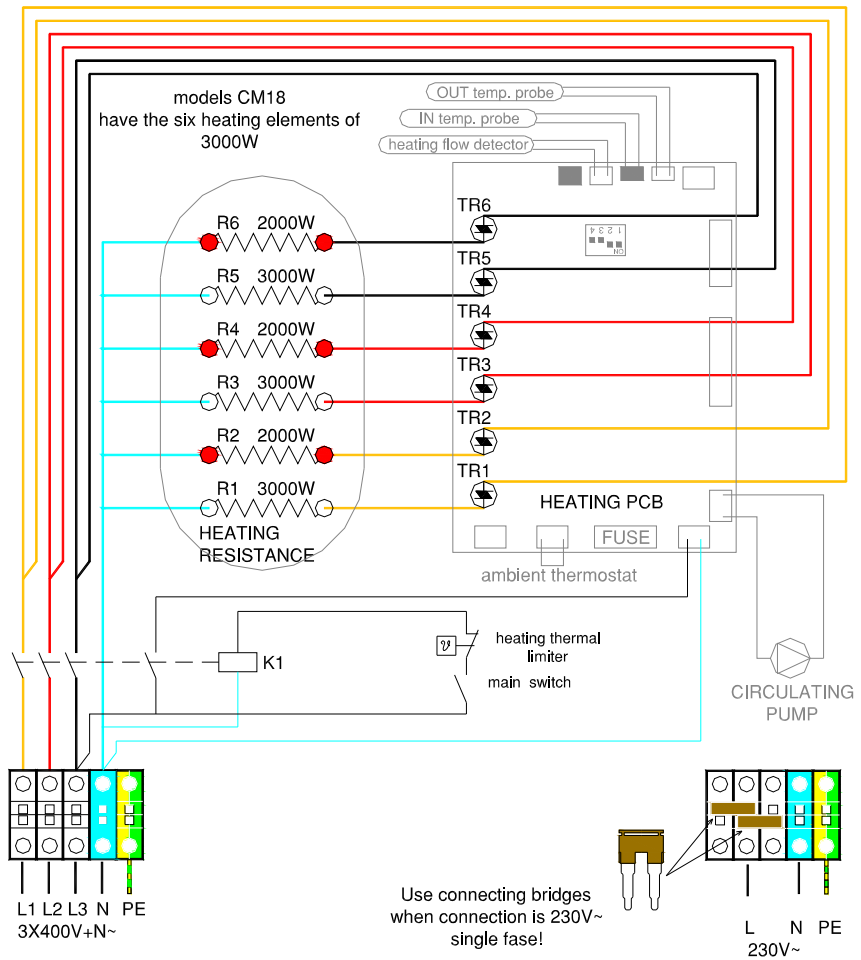



The symbol on the product or in its packaging indicates that this product may not be treated as household waste. Instead it shall be handed over to the applicable collection point for the recycling of electrical and electronic equipment. By ensuring this product is disposed of correctly, you will help prevent potential negative consequences for the environment and human health, which could otherwise be caused by inappropriate waste handling of this product. For more detailed information about recycling of this product, please contact your local city office, your household waste disposal service or the shop where you purchased the product. These instructions are only valid in the EU member states.



Supplier:

ELNUR UK Ltd.
Telephone +44(0)1942 670119
www.elnur.co.uk
info@elnur.co.uk

Manufactured by:

ELNUR S.A.
Travesía de Villa Esther, 11
28110, Algete - Madrid
Telephone +34 916281440



As part of the policy of continuous product improvement the manufacturer reserves the right to alter specifications without notice.